

TASCAM

TEAC Professional Division

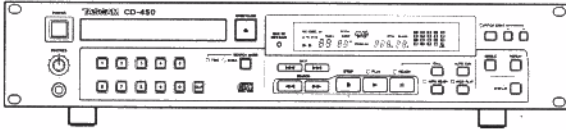

SERVICE MANUAL

CD-450

Compact Disc Player



NOTES

- PC boards shown are viewed from parts side.
- Parts marked with * require longer delivery time.
- The parts with no reference number or no parts number in the exploded views are not supplied.
- As regards the resistors and capacitors, refer to the circuit diagrams contained in this manual.
- ⚠ Parts marked with this sign are safety critical components. They must be replaced with identical components - refer to the appropriate parts list and ensure exact replacement.
- Parts of [] mark can be used only with the version designated.
[J]: JAPAN [US/C]: U. S. A. /CANADA [K]: KOREA [E]: EUROPE
[UK]: U. K. [A]: AUSTRALIA

注 意

- プリント基板図は部品面が示されています。
- *印の部品は納期が若干かかります。
あらかじめご了承ください。
- 分解図に部番のない部品及び品番のない部品は供給しません。
- 標準の抵抗、コンデンサーは省略してあります。
回路図を参照してください。
- ⚠印は安全重要部品です。
交換する時は必ずティアック指定の部品を使用してください。
- 仕向先
[J]: JAPAN [US/C]: U. S. A. /CANADA [K]: KOREA [E]: EUROPE
[UK]: U. K. [A]: AUSTRALIA

INSTRUCTIONS FOR SERVICE PERSONNEL

BEFORE RETURNING APPLIANCE TO THE CUSTOMER, MAKE LEAKAGE - CURRENT OR RESISTANCE MEASUREMENTS TO DETERMINE THAT EXPOSED PARTS ARE ACCEPTABLY INSULATED FROM THE SUPPLY CIRCUIT.

1. SAFETY INFORMATION

SAFETY INFORMATION

This product has been designed and manufactured according to FDA regulations "title 21, CFR, chapter 1, subchapter J, based on the Radiation Control for Health and Safety Act of 1968", and is classified as class 1 laser product. There is not hazardous invisible laser radiation during operation because invisible laser radiation emitted inside of this product is completely confined in the protective housings. The label required in this regulation is shown ①.

CAUTION

USE OF CONTROLS OR ADJUSTMENT OR PERFORMANCE OF PROCEDURES OTHER THAN THOSE SPECIFIED HEREIN MAY RESULT IN HAZARDOUS RADIATION EXPOSURE.

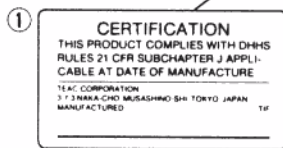
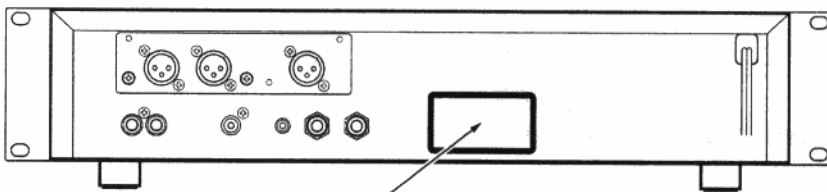

Optical pickup: Type : KSS-213C
 Manufacturer : SONY Corporation
 Laser output : Less than 0.4 mW on the objective lens
 Wavelength : 760 - 800 nm

• CAUTION • ACHTUNG • OBSERVERA • ADVARSEL

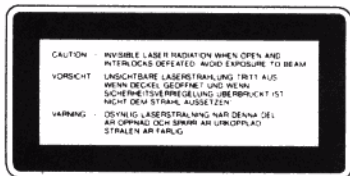

②

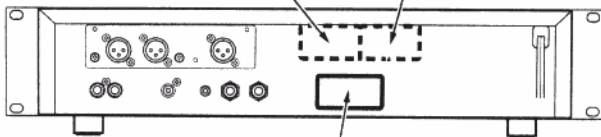
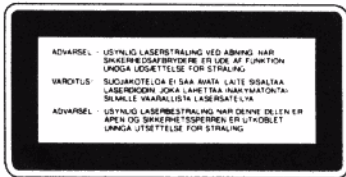

①

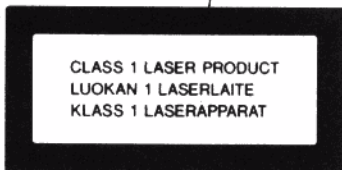

① THIS LABEL IS ATTACHED TO THE PLACE AS ILLUSTRATED TO INFORM THAT THE APPARATUS CONTAINS A LASER COMPONENT.

① DIESE AUFKLEBEMARKE IST AN DEM IN DER ABBILDUNG GEZEIGTEN ORT ANGEBRACHT UM DARAUF HINZUWEISEN, DASS IM INNERN DES GERÄTS EINE LASER-KOMPONENTE BEFINDET.

① PÅSKRIFTEN SITTER PÅ APPARATEN SOM VISAS SOM UPPMANING OM ATT APPARATEN OMFATTAR EN INBYGGD LASERKOMPONENT.

① DETTE MÆRKAT ER ANBRAGT SOM VIST I ILLUSTRATIONEN FOR AT ADVARE BRUGEREN OM AT APPARATET INDEHOLDER EN LASERKOMPONENT.

② DETTE MÆRKAT ER SOM VIST PÅ ILLUSTRATIONEN ANBRAGT PÅ INDERSIDEN AF TOPDÆKSLET FOR AT ADVARE BRUGEREN OM AT YDERLIGERE FREMTRÆNGEN VIL VÆRE FORBUNDET MED FARE FOR AT UDSÆTTE SIG FOR LASERSTRÅLING.

ADVARSEL - BETJENING AF ANDRE KONTROLLER OG REGULATORER ELLER BENYTTELSE AF ANDRE FREMGANGSMÅDER END BESKREVET HERI ER FORBUNDET MED FARE FOR UDSÆTTELSE FOR LASERSTRÅLING.

VARNING: APPARATEN INNEHÅLLER LASER KOMPONENT MED STRÅLNING ÖVERSTIGANDE KLAS 1

"ADVARSEL: USYNLIG LASERSTRÅLING VED ÅBNING NÅR SIKKERHEDSÅFBRYDERE ER UDE AF FUNKTION. UNNGÅ UDSÆTTELSE FOR STRÅLING."

"VAROITUS! SUOJAKOTELOA EI SAA AVATA, LAITE SISÄLTÄÄ LASERDIODIN, JOKA LÄHETTÄÄ (NÄKYMÄTÖNTÄ) SILMILLE VAARALLISTA LASERSÄTEILYÄ."

ADVARSEL: USYNLIG LASERBESTRÅLING NÅR DENNE DELEN ER ÅPEN OG SIKKERHETSSPERREN ER UTKOPLET UNNGÅ UTSETTELSE FOR STRÅLING.

2. SPECIFICATIONS

仕様

Disc: 8-cm/12-cm CD
Audio channel: 2 channels
Quantization: 16-bit linear
Sampling Frequency: 44.1 kHz
Analog output level
Line output (RCA)
Nominal output level: -10 dBV (load impedance 10 k Ω , unbalanced)
Maximum output level: +6 dBV (2Vrms)
Line output (XLR) [Optional LA-450]
Nominal output level: +4 dBu (load impedance 10 k Ω , balanced)
Maximum output level: +20 dBu
Headphone output (standard stereo phone jack):
 25 mW at max. (load impedance 32 Ω)
Digital output
Coaxial (RCA): IEC 60958 home-use (SPDIF)
Balanced (XLR) [Optional LA-450]:
 IEC 60958 broadcasting studios (AES/EBU)
Power requirements:
 120V AC, 60Hz (U. S. A./Canada model)
 230V AC, 50Hz (Europe/U. K. model)
 240V AC, 50Hz (Australia model)
 220V AC, 60Hz (Korea model)
Power consumption: 16 Watts
External dimensions: 482 X 104.5 X 310 mm
Weight: 5.1 kg
Typical Performance
Frequency Response: 20 Hz to 20 kHz \pm 1dB
Signal-to-Noise Ratio: Better than 90dB
Distortion: Less than 0.006 %
Channel Separation: Better than 85dB
Pitch control: Within \pm 12 % (1 % steps)
Auto cue level: -72/-66/-60/-54 dB

使用ディスク 8cm/12cm径CD
 音声チャンネル数 2チャンネル
 量子化ビット数 16ビット直線
 サンプル周波数 44.1kHz
 アナログ出力レベル
 ライン出力 (RCA)
 規定出力レベル -10dBV (負荷インピーダンス 10k Ω 、不平衡)
 最大出力レベル +6dBV (2Vrms)
 ライン出力 (XLR) [オプションLA-450]
 規定出力レベル +4dBu (負荷インピーダンス 10k Ω 、平衡)
 最大出力レベル +20dBu
 ヘッドホン出力 (ステレオ標準ジャック)
 最大25mW
 (負荷インピーダンス32 Ω)
 デジタル出力
 同軸 (RCA) IEC 60958 民生用 (SPDIF)
 バランス (XLR) [オプションLA-450]
 IEC 60958 放送局スタジオ用 (AES/EBU)
 使用電源 AC100V (50Hz - 60Hz)
 消費電力 16W
 外形寸法 482 X 104.5 X 310 mm
 質量 5.1kg

〈性能〉
 再生周波数特性 20Hz~20kHz \pm 1dB
 SN比 90dB以上
 歪率 0.006%以下
 チャンネルセパレーション 85dB以上
 ピッチコントロール \pm 12%以内 (1%単位)
 オートキューレベル -72/-66/-60/-54 (dB)

* Changes in specifications and features may be made without notice or obligation.

*仕様及び外観は予告なく変更する場合があります。

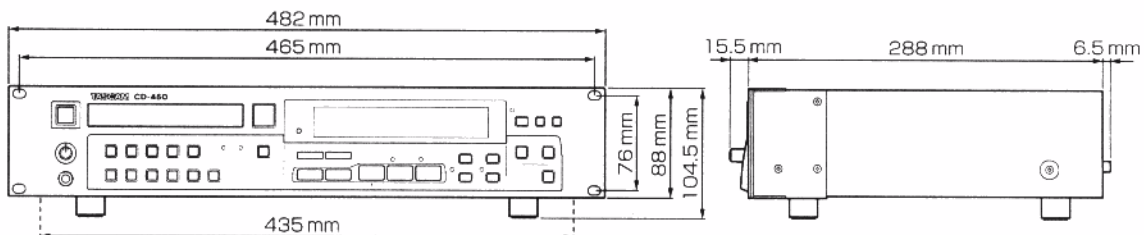

3. CHECKS

確認

1. Handling the pickup assembly

- Before servicing the pickup assembly be sure to prevent electrostatic-inducer destruction by grounding not only test equipment in use but also yourself.
* Electrostatic charge drastically shortens the operating life of the laser diode or possibly results in its destruction.
- Hold the slide base when handling the pick-up. (Fig. 3-1)
- LD terminals are factory-strapped before shipment to protect LD from electrostatic discharges during transportation. (Fig. 3-2) After connector insertion, unstrap the LD terminal with a soldering iron. The temperature of the soldering iron tip must be 320°C or below (30W) and the unstrapping should be performed quickly.
- Don't disassemble the pickup ass'y.
- Don't apply shock to the pickup ass'y.
- Don't place the assembly in a place subject to excessive dust, heat or moisture.
- The LD chip is manufactured from GaAs and GaAlAs, which contains toxic As (Arsenic). Parts removed in servicing should be disposed of with due care.

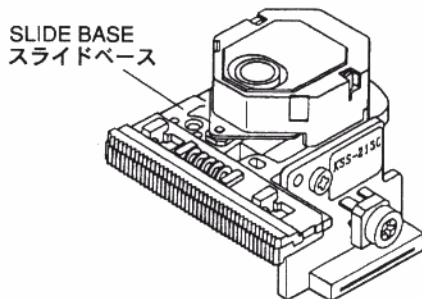

Fig. 3-1

1. ピックアップ ASSY の取扱

- ピックアップ ASSY を取り扱う場合は、測定器などに確実なアースを取ると共に、人体アースを行ない、静電破壊を十分防止してください。
* レーザーダイオードは、静電気が加わると寿命が著しく低下したり、または破損しますので十分注意してください。
- ピックアップ ASSY の取り扱いは、スライドベースを持って行ってください。(Fig. 3-1)
- LD の端子は、出荷時に輸送による静電破壊防止のためショートされています。(Fig. 3-2) ショート部の解放はコネクタを差し込んだ後、半田ゴテで行なってください。
半田ゴテは、コテ先温度が320°C以下(30W)のものを使用し、すみやかに行ってください。
- ピックアップ ASSY 本体の調整および分解などはしないでください。
- ピックアップ ASSY に落下・衝撃は加えないでください。
- ゴミ・ホコリなどの発生する場所、高温・多湿の場所は避けてください。
- LD のチップは GaAs + GaAlAs で有毒な As を含んでいます。サービスパーツの不良品は指定の方法で廃棄処理をしてください。

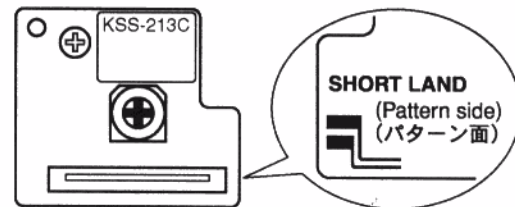

Fig. 3-2

2. Objective

- Never look directly into the LD or observe the laser beam through another lens or mirror.
- Don't touch the objective with fingers.
- If objective becomes dirty, playback will deteriorate. To clean the objective, moisten a good cleaning tissue, such as made by KODAK, in isopropyl alcohol and wipe the objective gently. Wipe off and excess fluid with a dry cleaning tissue.

2. 対物レンズについて

- 動作中のLDを直視したり、あるいは他のレンズやミラーを介して光束を観察すると危険ですから絶対に行なわないでください。
- レンズには手を触れないでください。
- レンズに汚れが付くと再生能力が低下しますので、次のように清掃してください。
レンズクリーニングペーパー (KODAK 社製など) に、イソプロピルアルコール (I.P.A) を浸して清掃をし、液が残らないように必ず拭きとってください。

3. Checking the pickup actuator operation

Before loading the disc, turn the power ON and check that the pickup actuator moves up and down six times. (If the pickup is not at inside on the disc, perform the above operation after moving the pickup to the inside.)

4. Focus offset check

1. Connect the jitter meter between RF terminal of R423 on the MAIN PCB and GND.
2. Play the track 1 of the test disc MCD-111, and check that the jitter value is 30nsec or less.
(RF level : 1 ± 0.2 Vp-p)

5. Audio check

3. ピックアップアクチュエーター動作チェック

電源ON時ピックアップアクチュエーターが6回上下動すること。(ピックアップが最内周にないときは、最内周に移動後上記動作すること。) ディスクは装着しない。

4. フォーカスオフセット確認

1. MAIN PCBのR423のRF端子とGND間にジッターメータを接続する。
2. テストディスクMCD-111の1曲目を再生したとき、ジッター値が30nsec以下であることを確認する。
(RFレベル : 1 ± 0.2 Vp-p)

5. オーディオ確認

ITEM 項目	DISC: MCD-111		SPECIFICATIONS 規格	REMARKS 備考
	TRACK No.	FREQUENCY/LEVEL		
1. Output level 出力レベル	2	1kHz, 0dB	UNBAL OUT : 2 ± 0.5 Vrms	PHONES VR : MAX 32 Ω load
			PHONES OUT : 0.9 ± 0.3 Vrms	
2. Channel level difference チャンネルレベル差	2	1kHz, 0dB	UNBAL OUT : 1 dB or less	
			PHONES OUT : 2.5 dB or less	
3. Harmonic distortion 高調波歪率	2	1kHz, 0dB	PITCH CON OFF : 0.006 % or less PITCH CON ON : 0.04 % or less	400Hz HPF in 20kHz LPF in
4. Frequency response 周波数特性	3~6	20Hz~20kHz, 0dB	Within ± 0.5 dB	reference level: 1kHz
5. S/N ratio S/N比	7	$-\infty$ dB	90 dB or better	20 kHz LPF in A-weighted
6. Channel separation チャンネル セパレーション	8, 10	1kHz, 0dB	85 dB or better	20 kHz LPF in A-weighted

4. EXPLODED VIEWS AND PARTS LIST

分解図とパーツリスト

EXPLODED VIEW-1

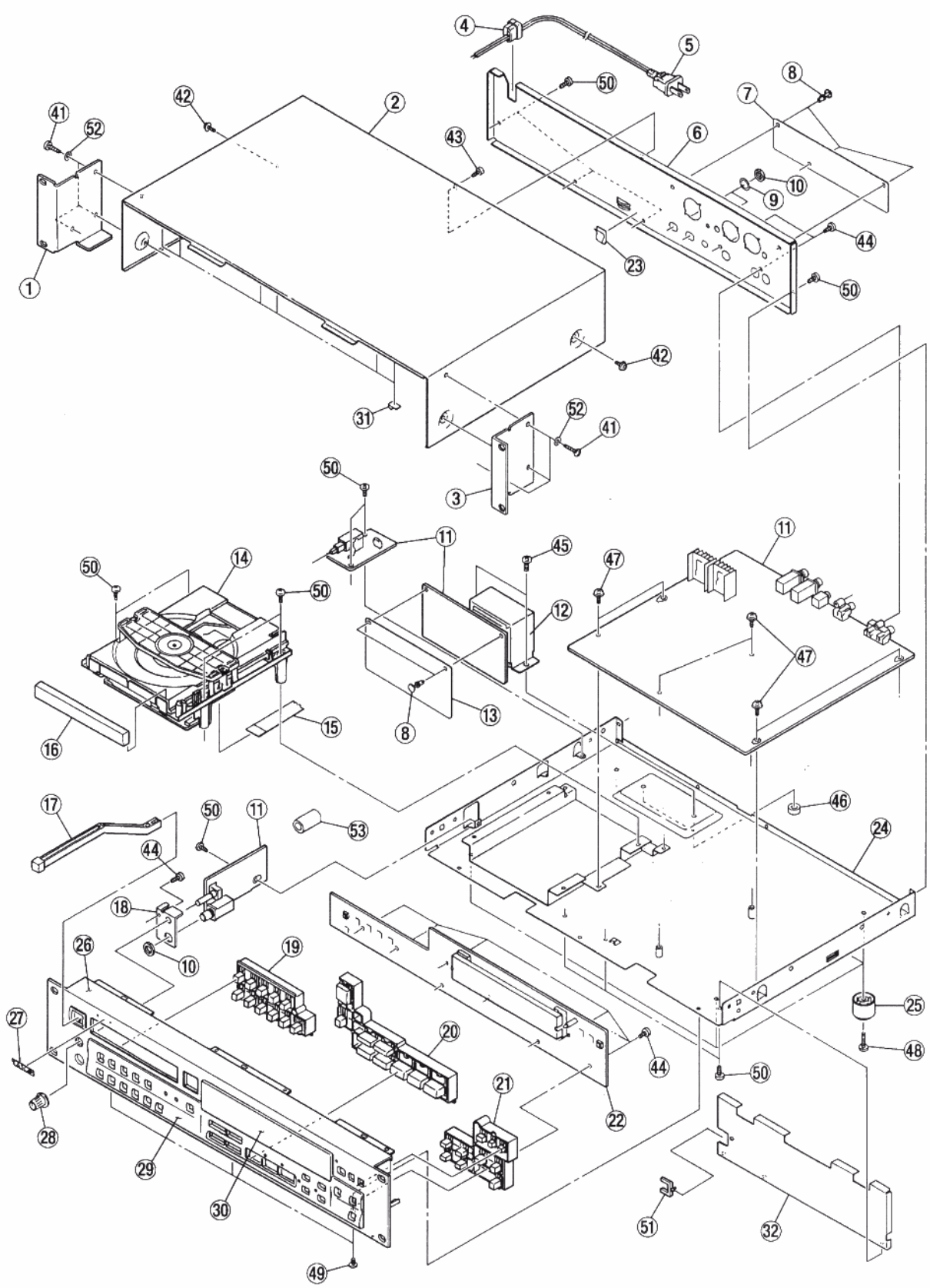

EXPLODED VIEW-1

REF. NO.	PARTS NO.	DESCRIPTION	REMARKS
1- 1	*9260303000	SIDE ANGLE L	
1- 2	*9260302500	BONNET	
1- 3	*9260302900	SIDE ANGLE R	
1- 4	△*9121000102	BUSHING, #2271 [J, K, A, E, UK]	
	△*9121000400	BUSHING, 6N3-4 [US/C]	
1- 5	△*9109026112	AC CORD [J]	
	△*E00423900A	AC CORD [K]	
	△*9109029400	AC CORD [US/C]	
	△*9109026010	AC CORD [A]	
	△*9109025711	AC CORD [E]	
	△*9109027701	AC CORD [UK]	
1- 6	*9260308300	REAR PANEL	
1- 7	*9260303100	XLR COVER	
1- 8	*9260296400	PUSH RIVET P3545	
1- 9	*9260260000	PVC WASHER	
1-10	*9781801200	NUT M12	
1-11	*9145251001	GATHER PCB A ASSY [J, US/C]	
	*9145251004	GATHER PCB A ASSY [K, A, E, UK]	
1-12	△ 9125121000	POWER TRANS	
1-13	*9260305701	TRANS PROTECT SHEET	
1-14	*9278371000	CD MECHA, KSL-2130CCM .	
1-15	*9107109000	FFC16P WIRE, CD MECHA	
1-16	*9260301900	TRAY PANEL	
1-17	*9260302100	POWER LINKAGE	
1-18	*9260302800	PHONE BRACKET	
1-19	*9260302200	KEY BUTTON 1	
1-20	*9260302302	KEY BUTTON 2	
1-21	*9260302400	KEY BUTTON 3	
1-22	*9145252000	GATHER PCB B ASSY	
1-23	*9260305600	FLAT CABLE CLAMP FC-15	
1-24	*9260306001	CHASSIS ASSY	
1-25	*5504676000	FOOT	
1-26	*9260301700	FRONT PANEL	
1-27	*9260271101	BADGE TASCAM SILVER	
1-28	M00002503A	KNOB, GB	
1-29	*9260301801	ESCUTHEON	
1-30	*9260302000	FL WINDOW	
1-31	*9260316300	STICK FINGER	
1-32	*9260316200	FRONT CHASSIS	
1-41	*9783243012	SCREW BTT-B M3X12 (BLK)	
1-42	*9783053006	SCREW, CAP-S M3X6 (BLK)	
1-43	*9783593008	SCREW, C-TITE M3X8(NI-BLK)	
1-44	*9783613008	SCREW, BTT-P M3X8 (BLK)	
1-45	*9783294008	SCREW, BTT-SSB M4X8	
1-46	*9260245902	COVER, SCREW	
1-47	*9783053006	SCREW, CAP-S M3X6 (BLK)	
1-48	*9783204018	SCREW, BTT-S M4X18	
1-49	*9783393006	SCREW, JOGGLING M3X6	
1-50	*9783243008	SCREW, BTT-B M3X8	
1-51	*9260316500	SQUARE SNAP BUSHING	
1-52	*9294209100	WASHER, FIBER 7. 3X3. 2X0. 5T	
1-53	*9162001300	FERRITE, ZCAT1325-053A	

EXPLODED VIEW-2

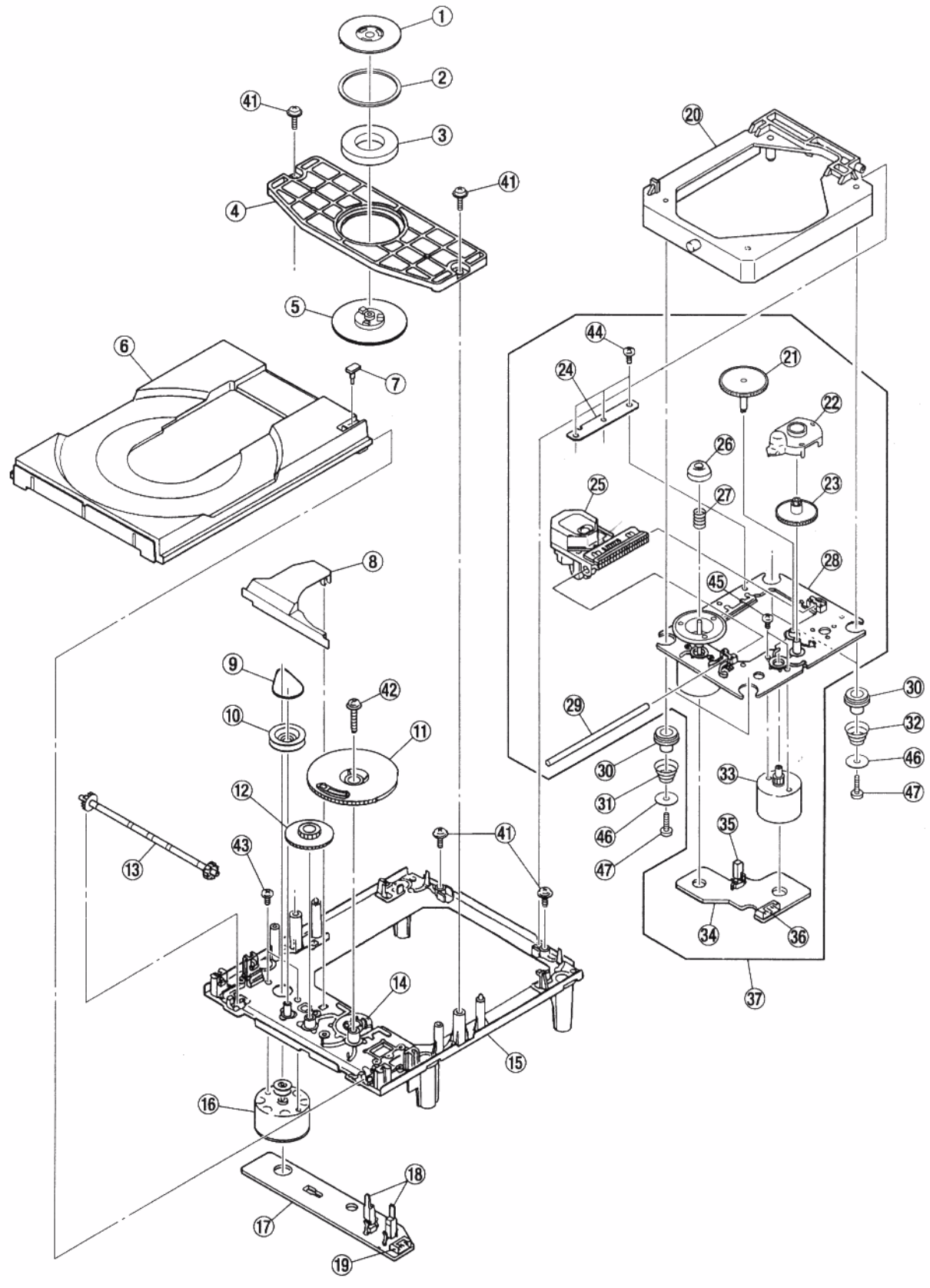

EXPLODED VIEW-2

REF. NO.	PARTS NO.	DESCRIPTION	REMARKS
2- 1	*9278383600	CHUCKING YOKE (S)	
2- 2	*9278383800	DAMPER	
2- 3	*9278316900	MAGNET	
2- 4	*9278372800	PLATE(S), CHUCKING	
2- 5	*9278372900	CHUCKING PULLY	
2- 6	*9278372100	TRAY (C) (2130)	
2- 7	*9278383400	TRAY STOPPER	
2- 8	*9278372300	COVER(S), GEAR	
2- 9	9278318700	LM BELT	
2-10	*9278372600	LOADING PULLY (S)	
2-11	9278372400	DRIVE GEAR (S)	
2-12	9278372500	MIDWAY GEAR (S)	
2-13	*9278372700	GEAR(S), TRAY	
2-14	*9278384600	CONTROL CAM (S)	
2-15	*9278372000	OUTSERT MAIN CHASSIS (S)	
2-16	9278373000	LOADING MOTOR ASSY	
2-17	*9155244600	LOADING PC BOARD	
2-18	9137004400	LEAF SWITCH	
2-19	*9144516200	CONNECTOR PIN 5P	
2-20	*9278372200	SUB CHASSIS 2130	
2-21	9278371900	GEAR (A) (S)	
2-22	*9278385000	COVER, GEAR (B) (RP)	
2-23	9278382900	GEAR (B) (RP)	
2-24	*9278383300	REINFORCEMENT (S)	
2-25	9278384900	OPTICAL PICKUP UNIT	
2-26	*9278383100	RING (LO) (S), CENTER	
2-27	*9278383000	SPRING (S), COMPRESSION	
2-28	9278371600	MOTOR CHASSIS ASSY (MB)	
2-29	*9278371800	SLED SHAFT	
2-30	*9278384300	INSULATOR	
2-31	*9278383900	COIL SPRING (FRONT)	
2-32	*9278384000	COIL SPRING (BACK)	
2-33	9278371700	MOTOR GEAR ASSY	
2-34	*9155244500	MOTOR (6P) (S) PCB	
2-35	9278322000	LEAF SWITCH	
2-36	*9144516100	CONNECTOR PIN 6P	
2-37	*9278384400	DRIVE UNIT	
2-41	*9278383500	SCREW +PTPWH 2. 6*7	
2-42	*9278384500	SCREW +PTPWH2. 6*16	
2-43	*9278384800	SCREW B2. 6*2. 5	
2-44	*9278383200	SCREW (2*5), TAPPING	
2-45	*9218382800	SCREW +P2*3	
2-46	*9278384100	WASHER 2130	
2-47	*9278384200	SCREW +2. 6*10 NO SLIT 2	

MAIN PCB

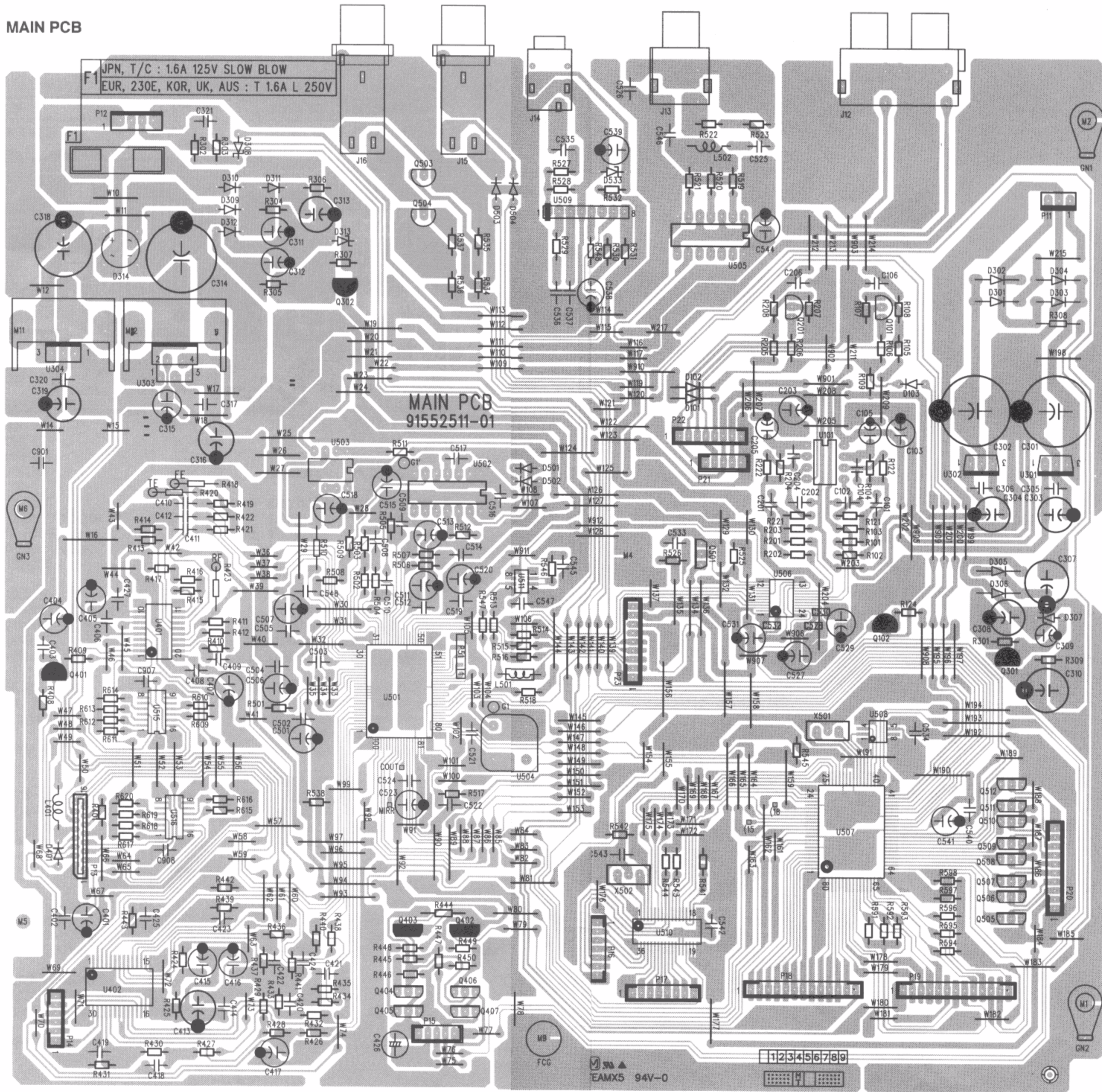

FRONT PCB

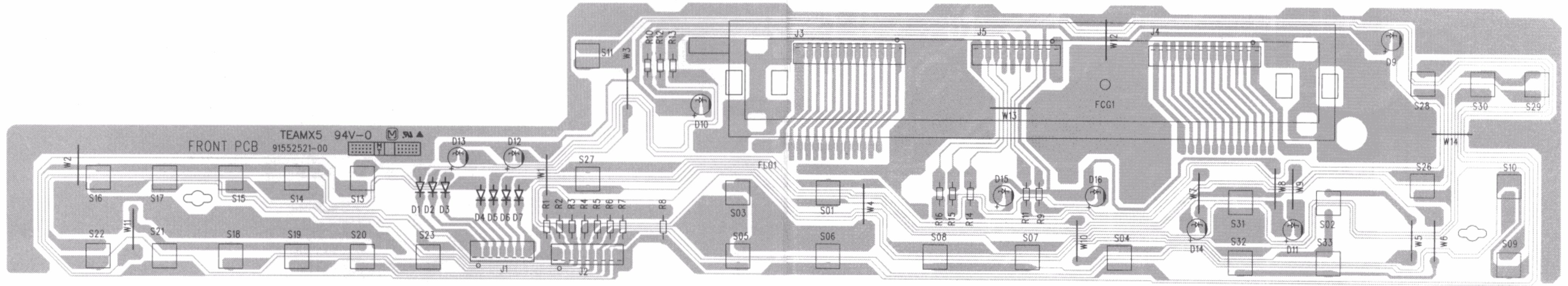

OPTION PCB (LA-450)

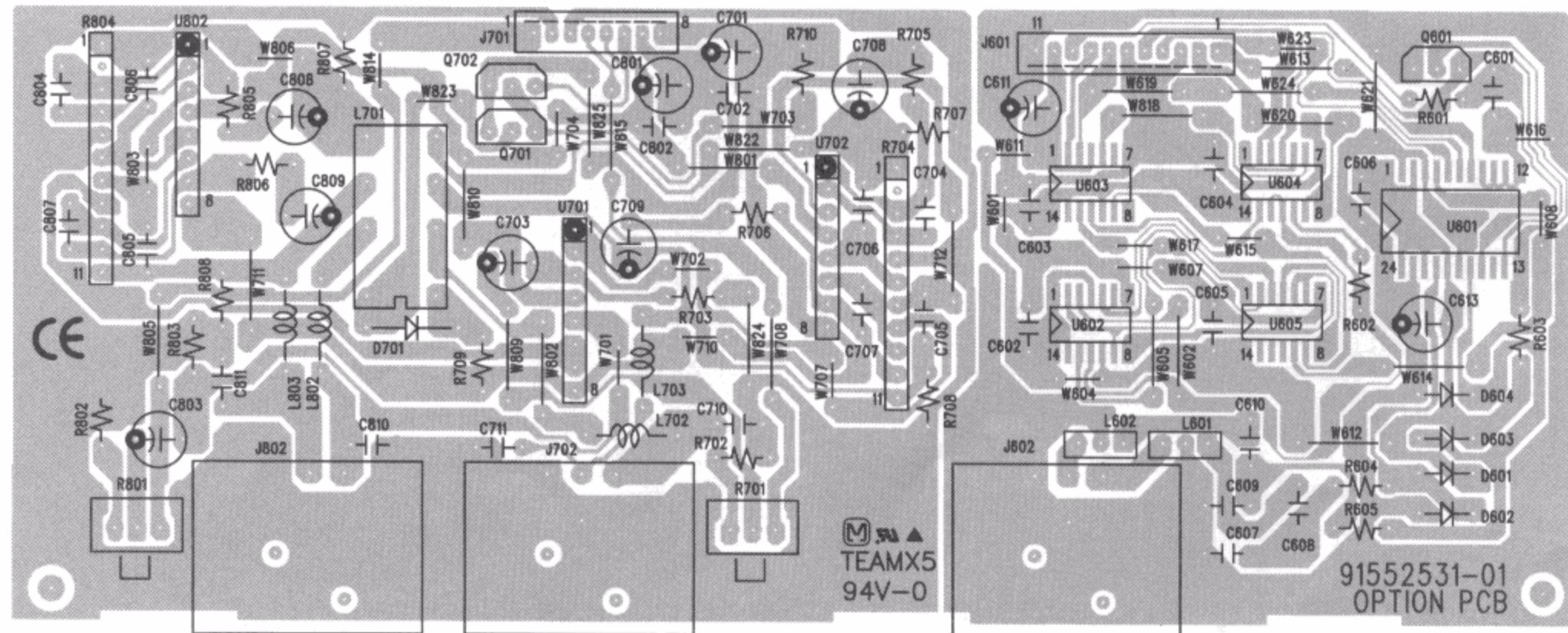

GATHER PCB A ASSY

REF. NO.	PARTS NO.	DESCRIPTION
	*9145251001	GATHER PCB A ASSY [J, US/C]
	*9145251004	GATHER PCB A ASSY [K, A, E, UK]
	*9155251000	GATHER PCB A
	*9155251100	MAIN PCB
	*9155251200	HEADPHONE PCB
	*9155251300	TRANS PCB
	*9155251400	POWER SW PCB
	*9783243008	SCREW BTT-B M3*8 (BLK)
	*9260316100	HEAT SINK 45MM
AC1, 3	9107108700	POWER 1P WIRE
C01, 02	△ 9120000500	SPARK KILLER 0.0047U/250V
C03	△ 9120000500	SPARK KILLER 0.0047U/250V
C301, 302	△ 9117275000	C, ELEC 2200M 35V
C307	△ 9117229021	C, ELEC 330M 25V TP
C308	△ 9117201020	C, ELEC 100UF 50V
C314	△ 9117274000	C, ELEC 2200M 25V
C318	△ 9117259000	C, ELEC 1000UF/25V
D101	9165022150	DIODE, TP 1SS133T
D102, 103	9165022150	DIODE, TP 1SS133T
D301-306	△ 9165020550	DIODE, LT 1N4003 TP 0.6MM
D307	9166037951	ZENER DIODE, RD33ESAB2
D308	9166032253	ZENER DIODE, MTZ J 6.2A
D309, 310	△ 9165022150	DIODE, TP 1SS133T
D311, 312	9165022150	DIODE, TP 1SS133T
D313	9166046751	ZENER DIODE, RD10ESB2
D314	△ 9165021500	BRIDGE RECTIFIER PB153M
D401	9165022150	DIODE, TP 1SS133T
D501-504	9165022150	DIODE, TP 1SS133T
D533	9166045351	ZENER DIODE, RD2.7ESAB2
F1	9150018000	FUSE HOLDER, 2-N1152
F1	△ 9150028000	T-LAG FUSE 1.6A 250V T [K, A, E, UK]
	△ 9150057000	FUSE 1.6A 125V 51S 016L [J, US/C]
GN1, 3	9229088000	EARTH PLATE B (GND-8)
GN4	9229088000	EARTH PLATE B (GND-8)
G1-G1	9107078901	SINGLE WIRE L=100
J01	9107110901	POWER 7P WIRE
J10	9144432000	PHONE JACK HTJ-064-09D
J11	9107109802	WIRE 100MM
J12	9144434000	PIN JACK 2P HSP-252V3-04
J13	9144433000	PIN JACK 1P HSP-241V10
J14	9144176000	MINIATURE JACK CPJ-3055
J15, 16	9143491001	JACK 064M WITH EARTHMETAL
L01	△ 9122020500	AC LINE FILTER LFH-601U
L401	9122018850	COIL 10UH EC24-100K-T5 TP
L501	9122020450	BEAD WBRN 3.5X6X0.8 TP
L502	9122019250	COIL, 4.7UH
P01	5327009600	TERMINAL, LAPPING 2P [K, A, E, UK]

GATHER PCB A ASSY

REF. NO.	PARTS NO.	DESCRIPTION
P11	9143171000	PLUG CONNECTOR B3B-EH 3P
P12	9143172000	PLUG CONNECTOR B4B-EH-A
P13	9144436000	PLUG 16P 006232016006800
P14	9143234000	PLUG B6B-PH 6P
P15	9143233020	PLUG 5P B5P-PH-K RED
P16	9143235000	PLUG B7B-PH 7P
P17, 22	9143236000	PLUG B8B-PH 8P
P18	9143241000	PLUG 13P (B13B-PH-H)
P19	9143241020	PLUG 13P B13B-PH-K RED
P20	9143238000	PLUG B10B-PH-K 10P
P21	9143233000	PLUG 5P B5P-PH-K
P23	9143237000	PLUG 9P (B9B-PH-K)
Q101, 201	9163310621	TR 2SC2878B TP
Q102	9163009920	TR, 2SA1015GR (TP)
Q301, 302	△ 9163009920	TR, 2SA1015GR (TP)
Q401	9163017920	TR, 2SA854SR TP
Q402, 403	9163011220	DTR, DTA 124ES TP
Q404-407	9163017820	TR, 2SC1741ASR TP
Q501	9163310420	DTR, DTC 124ES TP
Q503, 504	9163309420	TR, 2SC1815GR (TP)
Q505-512	9163310420	DTR, DTC 124ES TP
R110	9172034500	VR, RK09K12AZ003 20KAX2
R308	△ 9114525300	R, NONFLAMMABLE 1/4W 10
R444	△ 9114525200	R, NONFLAMMABLE 1/4W 4.7
SW01	△ 9135039200	POWER SW SDDL1077U
U101, 503	9167008100	IC, NJM4558D (8P)
U102	9167029500	IC NJM4560D
U301	△ 9167015600	IC, NJM78M15FA
U302	△ 9167015700	IC, NJM79M15FA
U303	△ 9167021500	IC, L78MR05 (5P)
U304	△ 9167039300	IC BA17807T
U401	9167039030	IC CXA1571M
U402	9167039230	IC LA6537M
U501	9167038930	IC CXD2545Q
U502	9167036500	IC SN74LS628
U504	9173013800	XTAL HHC55AT 16.9344MHZ
U505	9167036700	IC TC74HCU04AP
U506	9167039130	IC AK4319
U507	9167043330	MICOM UPD78045FGF-080
U508	9167038831	IC ATC93LC46
U509	9167028700	IC CXA1511L
U510	9167039430	IC UPD754302GS-060
U511	9167045030	IC TC7W04F
U515, 516	9167043430	TC74HC4053 AFN
X501	9173013700	CE, OSC 5MHZ CST5.00MGW
X502	9173008410	OSC, CERAMIC EF0EC4194A4

GATHER PCB B ASSY

REF. NO.	PARTS NO.	DESCRIPTION
	*9145252000	GATHER PCB B ASSY
	*9155252000	GATHER PCB B
	*9155252100	FRONT PCB
	*9260305900	FL TUBE HOLDER
D1-7	9165022150	DIODE TP 1SS133T
D10	9174015900	LED (AMBER) SLR-34DU 3F
D10	9260305500	LED HOLDER 11.5MM
D11, 14	9174015900	LED (AMBER) SLR-34DU 3F
D11, 14	9260303500	LED HOLDER 19MM
D12, 13	9174015900	LED (AMBER) SLR-34DU 3F
D12, 13	9260303600	LED HOLDER 17.5MM
D15	9174019300	LED SLR-34MG
D15, 16	9260303500	LED HOLDER 19MM
D16	9174015900	LED (AMBER) SLR-34DU 3F
D9	9174015900	LED (AMBER) SLR-34DU 3F

GATHER PCB B ASSY

REF. NO.	PARTS NO.	DESCRIPTION
D9	9260303300	LED HOLDER 13.5MM
FL01	9174024600	FL DISPLAY CM1594D
J1	9107109300	KEY MICOM 7P WIRE
J2	9107109400	KEY MICOM 8P WIRE
J3	9107109500	FL GRID 13P WIRE
J4	9107109600	FL SEGMENT 13P WIRE
J5	9107109700	LED 10P WIRE
S01-11	9136001820	TACT SW (SKHVBE3520-TK)
S13-23	9136001820	TACT SW (SKHVBE3520-TK)
S26-33	9136001820	TACT SW (SKHVBE3520-TK)

6. INCLUDED ACCESSORIES

付属品

INCLUDED ACCESSORIES

REF. NO.	PARTS NO.	DESCRIPTION	REMARKS
	*9101423300	OWNER'S MANUAL, JAPANESE [J]	
	*9101423400	OWNER'S MANUAL ENGLISH [EXCEPT J]	
	*E00455400A	REMOTE CONTROL UNIT, RC-450C [J]	
	*9260283901	INSALLATION SCREW ASSY	

CD-450

TASCAM

TEAC Professional Division

ティアック株式会社 電子機器事業部 〒180-8550 東京都武蔵野市中町3-7-3
 タスカムディビジョン ☎ (0422) 52-5072

技術的なお問合わせ、ご相談	タスカム営業技術	☎ (0422) 52-5106	〒180-8550 東京都武蔵野市中町3-7-3
サービスに関するお問合わせは、最寄りの営業所等へご連絡ください。 営業所にはサービス・センターが併設されています。	札幌営業所 仙台営業所 新潟サービス 大宮サービス サービス2課 お加東京営業所 千葉サービス 神奈川サービス 静岡サービス 名古屋営業所 京都サービス 大阪営業所 兵庫サービス 岡山サービス 広島営業所 福岡営業所 福岡サービス	☎ (011) 521-4101(代) ☎ (022) 227-1501(代) ☎ (025) 245-0103 ☎ (048) 642-4551 ☎ (0422) 52-5107 ☎ (03) 3592-2051(代) ☎ (043) 255-1281 ☎ (042) 746-6850 ☎ (054) 238-2431 ☎ (052) 702-3100(代) ☎ (075) 871-8730 ☎ (06) 6384-5201(代) ☎ (0727) 55-1002 ☎ (0862) 25-8601 ☎ (082) 294-4751(代) ☎ (092) 431-5781(代) ☎ (092) 936-5672	〒064-0807 札幌市中央区南7条西2-2 くぼたビル 〒980-0811 仙台市青葉区1番町2-5-5 中央ビル 〒950-0865 新潟県新潟市本馬越1-4-11 黒井ハイツ 〒331-0052 大宮市三橋2-8-4 6 〒180-8550 東京都武蔵野市中町3-7-3 〒100-0014 東京都千代田区永田町2-10-7 星方岡会館 〒260-0042 千葉市中央区椿森1-21-13 清水ビル 〒228-0803 相模原市相模大野7-14-9 グリーンシティビル 〒422-8034 静岡市高松1-12-1 寿道ハイツ105号 〒465-0025 名古屋市名東区上社5-406 〒616-8224 京都市右京区常盤窪町19 西垣ビル 〒564-0062 吹田市垂水町3-34-10 〒666-0004 兵庫県川西市萩原1-11-29 〒700-0945 岡山市新保1142-6 〒730-0846 広島市中区西川口町13-19 〒812-0008 福岡市博多区東光2-2-24 〒811-2202 福岡県粕屋郡志免町志免1041

TEAC CORPORATION	3-7-3, Nakacho, Musashino-shi, Tokyo 180 - 8550, Japan	Phone:(0422)52-5082
TEAC AMERICA, INC.	7733 Telegraph Road, Montebello, California 90640	Phone:(213)726-0303
TEAC CANADA LTD.	5939 Wallace Street, Mississauga, Ontario L4Z 1Z8, Canada	Phone:905-890-8008
TEAC UK LIMITED	5 Marlin House, Marlin's Meadow, The Croyley Centre, Watford, Herts. WD1 8YA, U.K.	Phone:01923-819899
TEAC DEUTSCHLAND GmbH	Bahnstrasse 12, 65205 Wiesbaden-Erbenheim, Germany	Phone:0611-71580
TEAC FRANCE S.A.	17, Rue Alexis-de-Tocqueville, CE 005 92182 Antony Cedex, France	Phone:01.42.37.01.02
TEAC NEDERLAND BV	Perkinsbaan 11a, 3439 ND Nieuwegein, Nederlands	Phone:030-6030229
TEAC AUSTRALIA PTY., LTD. A.C.N. 005 408 462	106 Bay Street, Port Melbourne, Victoria 3207, Australia	Phone:(03)9644-2442
TEAC ITALIANA S.p.A.	Via C. Cantù 11, 20092 Cinisello Balsamo, Milano, Italy	Phone:02-66010500